

Starna Scientific

The Spectroscopy Specialists



**Cells/Cuvettes for all
Spectrophotometer
Fluorimeter and
Laser applications**



Introduction to Starna®

The wide variety of Starna® products in this catalogue are manufactured in the Starna Scientific Ltd (formerly Optiglass Ltd) factory founded in 1964, whose lineage of optical expertise is traceable to the early part of the last century.

Starna Scientific is the manufacturing division of the international group of Starna® companies, who have a recognised world-wide reputation for quality, service, innovation and co-operation in the production and supply of spectrophotometer cells, optical components and certified reference materials.

During the 1950s, the founding members of the company developed and perfected the technique of fully fusing optically polished component parts by heat alone, without distortion. This major advance transformed the design and production of spectrophotometer cells and associated products. Continual development and improvement is reflected in the high quality world class Starna® products.

All manufacturing processes are carried out in an ISO 9000 certified production facility, from design and development of product to customised production machinery. The unique blend of skills including: cutting, slicing, grinding, polishing, conventional drilling, ultrasonic drilling and fusing as well as metallic, multi-layer and anti-reflection coating in one of many coating plants, achieves a complete vertically integrated manufacturing process.

During manufacture of all component parts, special care is taken to avoid contamination by the use of stringent cleaning processes. Together with mandatory inspection procedures these stringent cleaning processes ensure all products leave the factory in a pristine contamination-free condition, with an unconditional guarantee against faulty workmanship. This special treatment of cells together with internally profiled cells reduces bubble adhesion, particularly important in flow cell applications.

In addition to the ISO 9001 certified manufacturing facility, the **Starna Reference Material Calibration Laboratory** which has been UKAS accredited to ISO 17025 since 2001, also achieved ISO guide 34 in 2006, the highest level of accreditation, recognised world-wide. The unique combination of manufacturing, application and laboratory skills, permits full traceability throughout the whole production process, making Starna Scientific a unique partner to instrument manufacturers, dealers and retail customers worldwide who require completely independent guaranteed validation reference materials for analytical equipment.

Cell specifications

Starna® spectrophotometer cells and other quartz and glass assemblies, unless precluded by design, are assembled using a fully fused method of construction. This technique, pioneered and used by Starna Scientific since the mid 1950s, ensures that cells are fused into a single homogeneous entity using heat alone, without intermediate bonding materials. All cells are then carefully annealed to remove any residual strain from the fusing process. This ensures maximum physical strength as well as resistance to solvents. With few exceptions, most cells can be used safely with pressure differentials of up to 3 x 105Pa (3 Bar) and some up to 10x 105Pa (10 Bar).

General specifications

Windows parallel to: better than 3 minutes of arc
 Window flatness to: better than 4 Newton fringes
 Window polish, standard: 60/40 scratch/dig
 Window polish, laser: 20/10 scratch/dig

Material	Path lengths	Tolerance
Glass	less than 10mm	± 0.02mm
Glass	10 to 30mm	± 0.1mm
Glass	40 to 100mm	± 0.2mm
Special Optical Glass	up to 20mm	± 0.01mm
Special Optical Glass	30 to 100mm	± 0.02mm
Quartz	0.01 to 0.05mm	± 0.002mm
Quartz	0.1 to 0.4mm	± 0.005mm
Quartz	0.5 to 30mm	± 0.01mm
Quartz	40 to 100mm	± 0.02mm

Standard window thickness is 1.25mm, polished to better than 4 Newton Fringes per centimetre in the viewing area, typically flat to better than 1 micron (0.001mm) over the window area.

Although cells can be used with most solvents and acidic solutions, fluorinated acids such as Hydrofluoric Acid (HF) in all concentrations should be avoided as they will attack the quartz itself. Strong basic solutions (pH 9.0 and above) will also degrade the surface of the windows and shorten the useful life of the cells.

Flow cells with path lengths of less than 0.5mm are measured by an interference method both before and after final fusing. Calculation on this measurement provides an uncertainty of path length better than 0.2 microns (0.0002mm). Path length certification can be supplied for individual cells for a small additional charge. This should be requested at the time of ordering.

Water absorption band **OH content ppm (mg/g)**
Infrasil ≤ 8, Suprasil 300 ≤ 1.

Window material transmission properties

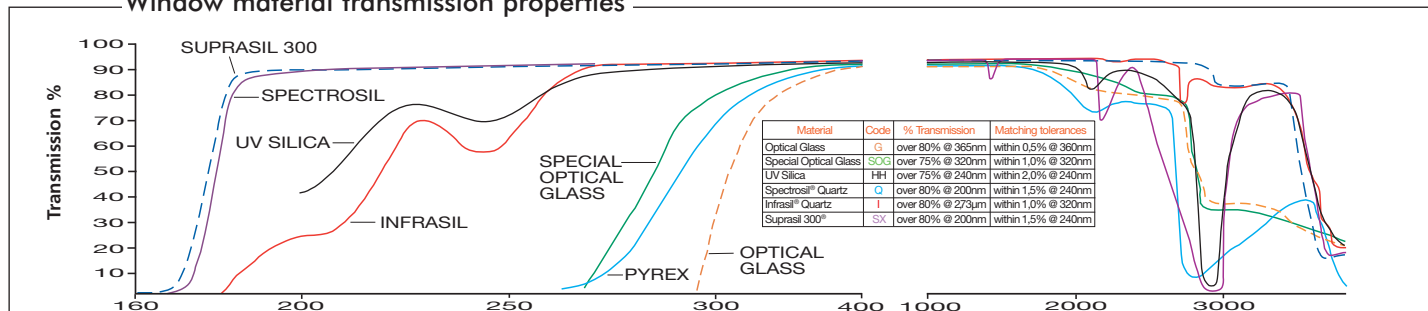

Registered Trade Marks: INFRASIL® & SUPRASIL 300® Heraeus Quarzglas GmbH, Hanau / Main, Germany.
 SPECTROSIL®, Saint-Gobain, England. PYREX® Corning Glass Works, U.S.A.

The above information illustrates the approximate transmission ranges of the guaranteed materials used in the production of Starna cells. The spectra does not take into account reflective losses from optical window surfaces which may vary depending on the material measured, resulting in actual measured transmission between 80%T and 90%T. Windows are normally 1.25mm thick and therefore the absorption of the windows themselves can be disregarded for normal analytical purposes.

Contents

Absorption cells	27	Sub-micro, de-bubbler	19
Accessories	28	Ultra-micro	19 & 20
Caps		Long aperture	15 - 17
Cell holders		Round aperture	19 & 20
Cell spacers		Wide aperture	15 - 17
Funnels		Medium aperture	15 & 16
Lids		Fluorescence reference materials	30
Magnetic stir bars		Fluorimeter cells	21 - 25
Mirror coatings		Standard rectangular	21
Quartz block inserts		Micro & semi-micro, with & without stopper	21 & 22
Stoppers		Micro cell adaptors - FCAs	21
Anaerobic cells	12	Sub-micro	22
Aspiration cells, micro and semi-micro	18	Flow cells, all types	14 & 24
CD matching	4	Triangular open top/stopper	23
Cell matching	4 & 2	Constant temperature	25
Cell specifications	2	Gel boat cells	27
Cell stirrer (Spinette)	30	Magnetic stirring cells	26
Colorimeter cells	27	Micro cells with lid or stopper	7
Connector fittings	29	Micro cells self-masking with lid or stopper	7
Constant temperature cells	25	Micro cells short	6
Cube cells	23	Micro cells short, self-masking	6
Cylindrical cells	10	Mixing cells	23
Constant temperature	25	NIST traceable certified reference materials	30
Short path	10	Polarimeter cells	26
Short path, micro	10	Quartz/Pyrex graded seals fused to cells	11
Standard	10	Rectangular cells with small screw caps	12
Large diameter	10	Reference materials, liquid and glass	30
With tube	10	Refractometer cells	25
With graded seal	11	Screw cap & septum cap cells GL14	12
Demountable cells, short path length	13	Semi-micro cells with lid or stopper	6
Dissolution cell construction	16	Semi-micro cells self-masking with lid or stopper	6
Divided cells	23	Small screw cap & septum cap cells	12
Dual path length cells	23	Standard rectangular cells with lid or stopper	5
Dye laser cells	26	Sub-micro cells with lid or vaned stopper	8
Flow cells	14-20	Sub-micro and multi-micro cells short	8
Dissolution cells	15-17	Sub-micro cells, low headspace	9
Fittings	29	Sub-micro cells with stopper	9
Fluorimeter	24	Suction cells	18
Fluorimeter HPLC	24	Tandem cells	23
HPLC	18	Terms of sale	30
Short path	14 & 17	Transmission specifications	2-4
Short path, demountable	14	Ultra-micro cells	9
In-line and Microscope analysis, in line	13-14	Ultra-micro lens cell	9 & 23
Standard & Semi-micro	15	UHV cells with stopcock	11
Sub-micro	16	Z Height dimension	4

How to order

Essential ordering information is shown under the **Blue column headings** throughout the catalogue. Detail shown under the black headings is additional descriptive and dimensional information and need not be included.
eg. to order Type **1/I/10** (Standard Rectangular, Infrasil, 10mm Path length)

Type No.	Window Materials	Path Length	Internal Width	External L W H			Nominal Vol. ml
1	G, SOG, PX, HH, Q, I, SX	10	10	12.5	12.5	45	3.500
▲	▲	▲					

eg. to order Type **19.01/Q/1/Z8.5** (Ultra-micro, Spectrosil, 1mm path length, 8.5mm Z dimension)

Type No.	Window Materials	Path Length	Z Height	Sample chamber W H		External L W H			Nominal Vol. ml
19.01	SOG, Q	1	8.5, 15, 20	5	1	12.5	12.5	40.5	0.0050
▲	▲	▲	▲						

Material specifications

Starna Scientific offer five primary window materials, Optical Glass (G) and Special Optical Glass (SOG) for the visible range. Spectrosil® Quartz (Q) or equivalent for the far UV range, Infrasil® Quartz (I) or equivalent for the near infra-red (IR) as well as Suprasil 300® (SX) or equivalent which transmits from the far UV to the near infra-red. Other window materials are also available such as Pyrex® (PX) and UV Silica (HH).

If a specific window material is required and is not shown in this catalogue please contact us for availability. All materials used are fully guaranteed to transmit greater than 80% over the following usable wavelength range:

Optical Glass	G	334 through 2500 nm
Special Optical Glass	SOG	320 through 2500 nm
Borosilicate	PX	325 through 2500 nm
UV Silica	HH	220 through 2500 nm
Spectrosil® Quartz	Q	190 through 2700 nm
Infrasil®	I	220 through 3800 nm
Suprasil 300® Quartz	SX	190 through 3500 nm

For fluorescent applications Spectrosil® is the recommended window material, as it does not exhibit any background fluorescence. Some other materials, especially glass and lower grades of quartz may have some background fluorescence.

The meticulous care taken in the quality of the polishing and unique construction of regular Starna® quartz fluorescent cells brings them within tolerances which are sufficiently stringent for them to be used in laser applications. These techniques are particularly relevant in the manufacture of much larger Ultra High Vacuum (UHV) cells.

Cell matching

Modern production and fusing techniques, together with consistent raw materials, have virtually eliminated the need for transmission matching in regular standard high grade quartz cells.

The extremely accurate physical path length tolerances used in production, stated on page 2, are essential especially on very short path lengths, for instance in dissolution measurements where multiple short path length cells may be used. Such flow cells Types 73, 74, 75, 583, 584 and 585 each have a unique fully traceable serial number engraved on the window. Cells with path lengths less than 0.5mm are measured using an interference method both before and after final fusing to provide a path length uncertainty calculation better than 0.2 microns (0.0002 mm). A certificate of path length and full production traceability can be provided for each individual cell on request, for a small additional charge.

Cells manufactured for **Circular Dichroism(CD)** must have strain-free oriented windows and the complete cell carefully annealed. This process incurs an additional charge for each cell. Cells required for **CD** must have this suffix **CD** added to the part number e.g. 34/Q/50/CD.

Z Height dimension - IMPORTANT!

The 'Z' height is the distance from the bottom of the cell holder cavity to the centre of the incident light beam profile, which can be round, rectangular or curved. For the most efficient use of energy and sample volume the sample chamber aperture should ideally encompass the light beam with a small extra margin to avoid beam clipping.

The 'Z' height of the cell, the distance from the centre of the cell sample chamber aperture to the base of the cell, should match to that of the instrument.

Manufacturers have generally designed their instruments with 'Z' dimensions ranging from 5 to 20mm with 8.5 or 15mm being the most popular.

Choosing the correct cell 'Z' height is very important when the aperture in the cell is very small, as in sub-micro cells and micro flow cells.

The standard 'Z' heights for any cell, where this information is critical, are shown in a separate column in the information tables, headed 'Z' Height. Other 'Z' dimensions can be supplied on request.

The correct 'Z' height should be added to the part number e.g. if 8.5mm is required it should be shown as follows 73.4/SOG/10/Z8.5. As a double check at the time of ordering, it is beneficial to state the instrument make and model number for which the cell is required.

All dimensions stated in this catalogue are in millimetres unless otherwise indicated

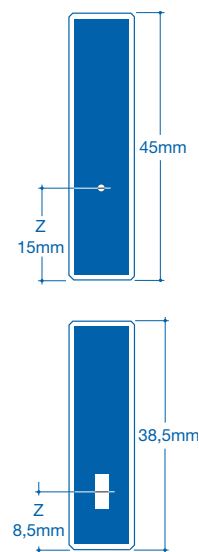

When cells matched for transmission are required, mainly but not exclusively for less consistent materials such as Glass and Special Optical Glass where transmission characteristics from melt to melt differ, each measured cell is given a match code relative to its transmission at a given wavelength as measured on a spectrophotometer. The transmission matching tolerances at measured wavelengths are shown as follows:

Window Material	Matching Tolerance	Measured at Wavelength
Optical Glass	0.5%	350nm
Special Optical Glass	1.0%	320nm
Borosilicate	1.0%	320nm
UV Silica	1.5%	240nm
Spectrosil® Quartz	1.5%	200nm
Infrasil® Quartz	1.5%	240nm
Suprasil 300®	1.5%	240nm

The matching codes are only of real value when comparing new cells as transmission characteristics change during use because of surface contamination or wear due to cleaning processes. Therefore a brand new cell may not identically match an older used cell of the same match code.

Type 31. Cylindrical. Short path length

- Two polished windows.
- Closed by PTFE stopper, providing a liquid-tight seal.

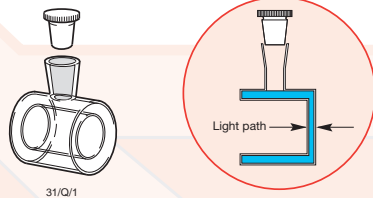

31/Q/1

Type No.	Window Materials	Path Length	Internal Dia.	External Dia.	L	Nominal Vol. ml
31	Q, I, SX	0.01	15	22	22.5	2.15
31	Q, I, SX	0.05	15	22	22.5	2.15
31	Q, I, SX	0.10	15	22	22.5	2.15
31	Q, I, SX	0.20	15	22	22.5	2.18
31	Q, I, SX	0.50	15	22	22.5	2.22
31	Q, I, SX	1	15	22	22.5	2.31
31	Q, I, SX	2	15	22	22.5	2.49
31	Q, I, SX	5	15	22	22.5	3.02

Type 31/B. Cylindrical. Short path length, micro.

- Reduced sample volume.
- Two polished windows.
- Two filling ports, closed by PTFE stopper, providing a liquid-tight seal.

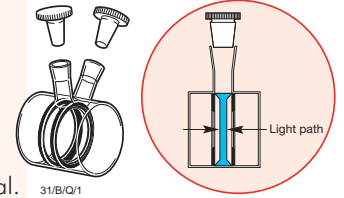

31/B/Q/1

Type No.	Window Materials	Path Length	Internal Dia.	External Dia.	L	Nominal Vol. ml
31/B	Q	0.01	13	22	22.5	0.140
31/B	Q	0.05	13	22	22.5	0.151
31/B	Q	0.10	13	22	22.5	0.165
31/B	Q	0.20	13	22	22.5	0.194
31/B	Q	0.50	13	22	22.5	0.278
31/B	Q	1	13	22	22.5	0.420
31/B	Q	2	13	22	22.5	0.703
31/B	Q	5	13	22	22.5	1.552

Type 32. Cylindrical. Standard

- Two polished windows.
- Closed by one PTFE stopper, providing a liquid-tight seal.

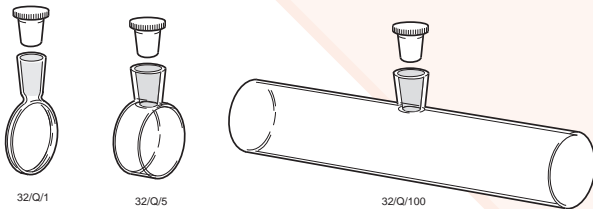

32/Q/1

32/Q/5

32/Q/100

Type No.	Window Materials	Path Length	Internal Dia.	External Dia.	L	Nominal Vol. ml
32	SOG, PX, Q, I, SX	1	19	22	3.5	0.28
32	SOG, PX, Q, I, SX	2	19	22	4.5	0.56
32	SOG, PX, Q, I, SX	5	19	22	7.5	1.40
32	SOG, PX, Q, I, SX	10	19	22	12.5	2.80
32	SOG, PX, Q, I, SX	20	19	22	22.5	5.60
32	SOG, PX, Q, I, SX	50	19	22	52.5	14.10
32	SOG, PX, Q, I, SX	100	19	22	102.5	28.20

Type 34. Cylindrical. Standard

- Two polished windows.
- Closed by two PTFE stoppers, providing a liquid-tight seal.

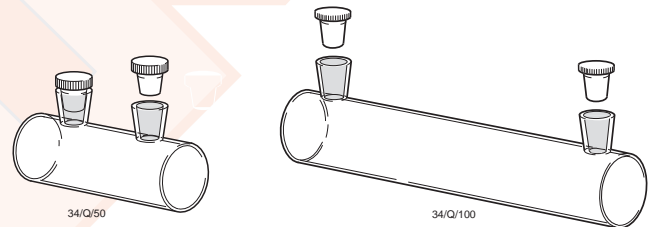

34/Q/50

34/Q/100

Type No.	Window Materials	Path Length	Internal Dia.	External Dia.	L	Nominal Vol. ml
34.4	Q	100	4	6	102.5	1.30
34.8	Q	100	8	10	102.5	5.10
34.10	Q	100	10	12	102.5	7.86
34.12	Q	100	12	14	102.5	11.35
34	SOG, PX, Q, I, SX	50	19	22	52.5	14.10
34	SOG, PX, Q, I, SX	100	19	22	102.5	28.20
34	Q	200	19	22	202.5	56.40

Type 35. Cylindrical. Large diameter

- Two polished windows.
- Closed by PTFE stopper, providing a liquid-tight seal.

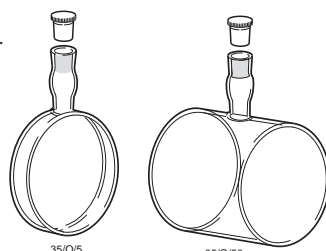

35/Q/5

35/Q/50

Type No.	Window Materials	Path Length	Internal Dia.	External Dia.	L	Nominal Vol. ml
35	SOG, PX, Q, I	2	47	50	4.5	3.40
35	SOG, PX, Q, I	5	47	50	7.5	8.50
35	SOG, PX, Q, I	10	47	50	12.5	17.00
35	SOG, PX, Q, I	20	47	50	22.5	35.00
35	SOG, PX, Q, I	50	47	50	52.5	86.00
35	Q	100	47	50	102.5	172.00

Type 37. Cylindrical with tube

- Two polished windows.
- Tube material the same as cell body.
- Available on request with restriction for easy seal.

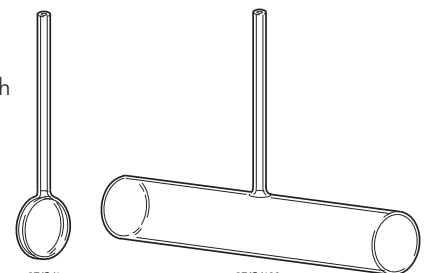

37/Q/1

37/Q/100

Type No.	Window Materials	Path Length	Int. Dia.	Ext. Dia.	L	Tube ID.	Tube OD.	L	Nominal Vol. ml
37	SOG, PX, Q, I, SX	1	19	22	3.5	2	4	70	0.28
37	SOG, PX, Q, I, SX	2	19	22	4.5	2	4	70	0.56
37	SOG, PX, Q, I, SX	5	19	22	7.5	2	4	70	1.40
37	SOG, PX, Q, I, SX	10	19	22	12.5	2	4	70	2.80
37	SOG, PX, Q, I, SX	20	19	22	22.5	2	4	70	5.60
37	SOG, PX, Q, I, SX	50	19	22	52.5	2	4	70	14.10
37	SOG, PX, Q, I, SX	100	19	22	102.5	2	4	70	28.20

Rectangular & Cylindrical with Quartz to Pyrex graded seal (GS)

- Quartz to pyrex graded seal fully fused to cell.
- Different diameters and lengths of graded seals can be supplied on request.

Rectangular & Cylindrical with straight tube (SBT)

- Quartz tube fully fused to quartz cell.
- Pyrex tube fully fused to pyrex cell
- Different diameters & lengths of straight bore tube can be supplied on request.

Rectangular for Low Temperature (HLT/GS) with Quartz to Pyrex graded seal

- 2mm thick walls.
- Fully fused 'welded' joints.
- Quartz to pyrex graded seal

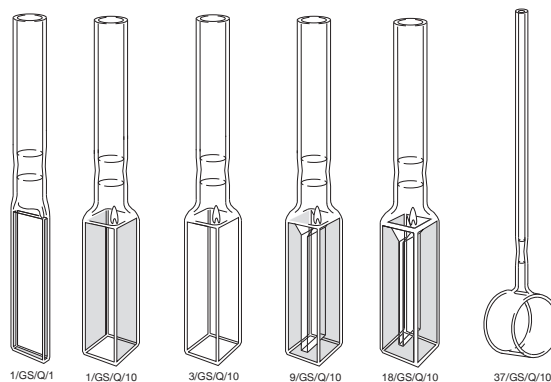

Type No.	Window Materials	Path Length	Internal Width	Internal Dia.	L	External W	H	D	Tube ID.	OD.	L	Nominal Vol. ml	Remarks
1/GS or SBT	Q, I	1	10		3.5	12.5	115		8	10	70	0.40	Macro/Standard rectangular
1/GS or SBT	Q, I	2	10		4.5	12.5	115		8	10	70	0.70	Macro/Standard rectangular
1/GS or SBT	Q, I	5	10		7.5	12.5	115		8	10	70	1.70	Macro/Standard rectangular
1/GS or SBT	Q, I	10	10		12.5	12.5	115		8	10	70	3.50	Macro/Standard rectangular
3/GS or SBT	Q, I	10	10		12.5	12.5	115		8	10	70	3.50	Fluorimeter
9/GS or SBT	Q, I	10			12.5	12.5	115		8	10	70	1.40	Semi-micro
18/GS or SBT	Q, I	10			12.5	12.5	115		8	10	70	0.70	Micro
37/GS	Q, I	1		19	3.5			22	2	4	70	0.28	Cylindrical
37/GS	Q, I	2		19	4.5			22	2	4	70	0.56	Cylindrical
37/GS	Q, I	5		19	7.5			22	2	4	70	1.40	Cylindrical
37/GS	Q, I	10		19	12.5			22	2	4	70	2.80	Cylindrical
37/GS	Q, I	20		19	22.5			22	2	4	70	5.60	Cylindrical
37/GS	Q, I	50		19	52.5			22	2	4	70	14.00	Cylindrical
37/GS	Q, I	100		19	102.5			22	2	4	70	28.00	Cylindrical
1/HLT/GS	Q	10	8.5	10	12.5		115		8	10	70	3.5	Macro/Standard rectangular
3/HLT/GS	Q	10	8.5	10	12.5		115		8	10	70	3.5	Fluorimeter

Type 700. UHV Stopcock cells

- High vacuum patented stopcock.
- All cells will withstand evacuation $<10^{-11}$ Tor.
- PTFE threaded.
- Can be fused to most quartz cells.
- Stopcock itself can withstand pressure up to 5 bar (5×10^5 Pa).
- For cell pressure guidance; please enquire.

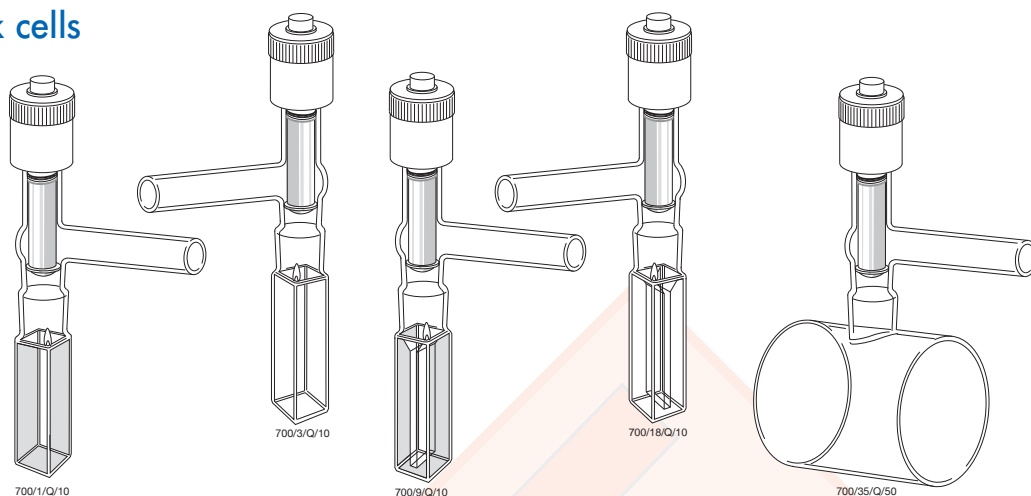

Type No.	Window Material	Path Length	L	External W	H	Side arm ID.	OD.	Length	Remarks
700/1	Q	10	12.5	12.5	~ 135/150	10	13	50	Type 1 Macro
700/3	Q	10	12.5	12.5	~ 135/150	10	13	50	Type 3 Fluorimeter
700/9	Q	10	12.5	12.5	~ 135/150	10	13	50	Type 9 Semi micro
700/18	Q	10	12.5	12.5	~ 135/150	10	13	50	Type 18 Micro
700/32	Q	10	22.5	22Ø	~ 135/150	10	13	50	Type 32 Cylindrical
700/32	Q	20	22.5	22Ø	~ 135/150	10	13	50	Type 32 Cylindrical
700/32	Q	40	42.5	22Ø	~ 135/150	10	13	50	Type 32 Cylindrical
700/32	Q	50	52.5	22Ø	~ 135/150	10	13	50	Type 32 Cylindrical
700/32	Q	100	102.5	22Ø	~ 135/150	10	13	50	Type 32 Cylindrical
700/35	Q	50	52.5	50Ø	~ 135/150	10	13	50	Type 35 Cylindrical
700/35	Q	100	102.5	50Ø	~ 135/150	10	13	50	Type 35 Cylindrical

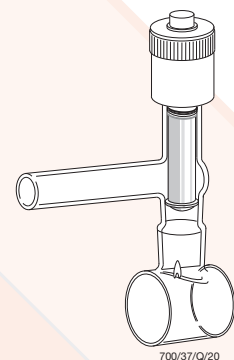

Rectangular Anaerobic with screw cap (GL14)

- Closed by screw cap or septum cap.
- **GL14/C** closed cap.
- **GL14/S** septum cap to allow filling, extraction or gas flow with syringe needle(s) through the silicone seal.
- Septum aperture diameter 9mm.
- Cap withstands pressure up to 5×10^5 Pa (5 bar).
- **GL14** can be fused to most rectangular and cylindrical cells with either one or two ports. Particularly suitable for stopping evaporation in cells used for stirring eg. **9/MS/GL14/Q/10**.

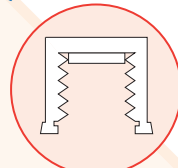

Plain cap
GL14/C

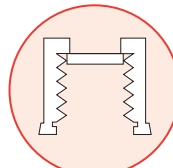

Septum cap
GL14/S

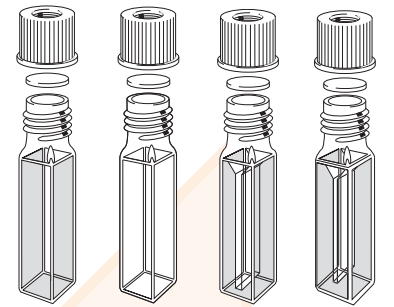

Type No.	Window Materials	Path Length	Internal Width	External L W H	Nominal Vol. ml	Remarks
1/GL14	SOG, Q, I	1	10	3.5 12.5 66	0.400	Macro/Rectangular
1/GL14	SOG, Q, I	2	10	4.5 12.5 66	0.800	Macro/Rectangular
1/GL14	SOG, Q, I	5	10	7.5 12.5 66	1.600	Macro/Rectangular
1/GL14	SOG, Q, I	10	10	12.5 12.5 66	3.500	Macro/Rectangular
9/GL14	SOG, Q, I	10	4	12.5 12.5 66	1.400	Semi-micro
9/B/GL14	Q, I	10	4	12.5 12.5 66	1.400	Semi-micro. Self masking
18/GL14	SOG, Q, I	10	2	12.5 12.5 66	0.700	Micro
18/B/GL14	Q, I	10	2	12.5 12.5 66	0.700	Micro. Self masking
3/GL14	SOG, Q, I	10	10	12.5 12.5 66	3.500	Fluorimeter
9-F/GL14	Q	10	10	12.5 12.5 66	1.400	Semi-micro. Fluorescent
18-F/GL14	Q	10	10	12.5 12.5 66	0.700	Micro. Fluorescent
16. **/GL14	Q	10	10	12.5 12.5 66	**all volumes	Sub-micro.
16. **-F/GL14	Q	10	10	12.5 12.5 66	**all volumes	Sub-micro.

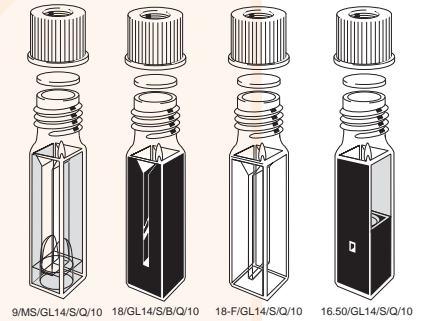

Cylindrical Anaerobic with screw cap(s) (GL14)

- **GL14** can be fused to most cylindrical cells with either one or two ports.

Type No.	Window Materials	Path Length	External Length	Internal Diameter	Nominal Vol. ml
32/GL14	SOG, PX, Q, I, SX	10	12.5	19	2.800
32/GL14	SOG, PX, Q, I, SX	20	22.5	19	5.600
32/GL14	SOG, PX, Q, I, SX	50	52.5	19	14.100
32/GL14	SOG, PX, Q, I, SX	100	102.5	19	28.200
34/GL14	SOG, PX, Q, I	50	52.5	19	14.100
34/GL14	SOG, PX, Q, I	100	102.5	19	28.200



32/GL14/S/Q/10

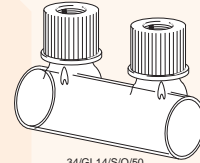

34/GL14/S/Q/50

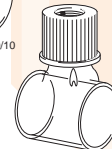

32/GL14/S/Q/20

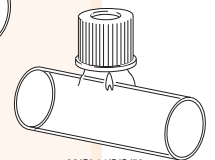

32/GL14/S/Q/50

Rectangular Anaerobic for use with rubber septa seal

- **SBT10.15** tops suitable for rubber septa seal for Anaerobic environments. Tubing 15mm long, 10mm I.D.

Type No.	Window Materials	Path Length	Internal Width	External L W H	Tube D.OD.L	Nominal Vol. ml	Remarks
1/SBT10.15	Q, I	10	10	12.5 12.5 59	10 13 15	3.500	Macro/Standard rectangular
3/SBT10.15	Q, I	10	10	12.5 12.5 59	10 13 15	3.500	Fluorimeter
9/SBT10.15	Q, I	10	4	12.5 12.5 59	10 13 15	1.400	Semi-micro
18/SBT10.15	Q, I	10	2	12.5 12.5 59	10 13 15	0.700	Micro

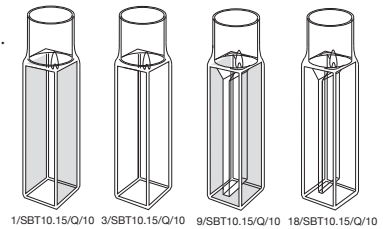

Rectangular with small screw cap (ST)

- Closed with screw cap, with or without septum aperture.
- Outside diameter of cap is less than the cross-section of the cell.
- Septum aperture diameter - 6mm.
- **ST/C** closed cap.
- **ST/S** septum cap to allow filling, extraction or gas flow with syringe needle(s) through silicone seal which has a PTFE face.



1/ST/Q/10



3/ST/Q/10

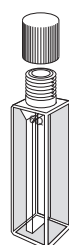

9/ST/Q/10

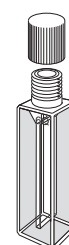

18/ST/Q/10

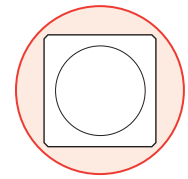

Top view

Type No.	Window Materials	Path Length	Internal Width	External L W H	Nominal Vol. ml	Remarks
1/ST	Q, I	10	10	12.5 12.5 58	3.500	Macro/Standard rectangular
1.30/ST	Q	10	10	12.5 12.5 43	2.800	For Reference Adaptor Plate
3/ST	Q, I	10	10	12.5 12.5 58	3.500	Fluorimeter
9/ST	Q, I	10	4	12.5 12.5 58	1.400	Semi-micro
18/ST	Q, I	10	2	12.5 12.5 58	0.700	Micro



Starna scientific

Starna Scientific Limited

52-54 Fowler Road, Hainault,
Essex IG6 3UT, UK.

Starna Scientific Sales & Technical Assistance

Tel: +44 (0)20 8501 5550 Fax: +44 (0)20 8501 1118
Email: sales@starna.com
www.starna.com

Starna Cells Inc.
PO Box 1919
Atascadero
CA 93423
USA

Tel: 800 228 4482
805 466 8855
Fax: 805 461 1575
Email: info@starnacells.com

Starna Pty. Ltd.
PO Box 6751
Baulkham Hills B C
NSW 2153
AUSTRALIA

Tel: 61-2-9659 8088
Fax: 61-2-9659 8511
Email: info@starna.com.au

Starna GmbH
Postfach 1206
D-64311
Pfungstadt
GERMANY

Tel: +49 (0) 6157 2813
Fax: +49 (0) 6157 85564
Email: starna@t-online.de

Local Distributor

Terms of sale

Normal terms of sale are net 30 days, FOB Hainault to recognised accounts. Under our terms of sale 'Title of ownership of any goods shipped does not transfer until the goods have been paid for in full'.

Product warranty

Starna® Spectrophotometer and Fluorimeter cells are warranted to meet the specifications shown on page 2 of this catalogue and be equal to or better than the dimensional tolerance for each cell listed. Stringent quality control is exercised throughout production with only guaranteed and brand named raw materials used, so that cells will perform to the highest specification for any given design. Any goods to be returned under warranty require a Return of Merchandise Authorisation (RMA) number, which can be obtained by calling our Customer Service Department. We reserve the right to change the design or specification of any product without prior notification.

Technical information

Technical staff are available to assist in the selection of cell material or physical configuration to satisfy individual applications.

Method of shipment

Prices do not include shipping costs, duty or tax. Normal shipment, unless otherwise specified, is by recorded letter or parcel post. Overnight service is available via Carrier or Data Post. Overseas shipments utilise Air parcel or letter post, UPS, TNT, DHL, FedEx or regular air freight. Unless specified otherwise all shipping charges are prepaid and added to the sales invoice.

Stock items

Great efforts are made to stock the widest range of products so that purchase orders can be shipped the day they are received. Any item temporarily out of stock will be back ordered and shipped when available from production unless otherwise instructed.

All rights reserved. No part of this publication may be reproduced, stored in a retrieval system, or transmitted, in any form or by any means, electronic, mechanical, photocopying, recording or otherwise, without the prior permission of Starna Scientific Ltd.

First published 1972. Revised 1978, 87, 91, 95, 01 & 03. This edition UK 09/10. The copyright © of this catalogue is held by the Starna® group of companies